

Jin-Soo Kim
(jinsoo.kim@snu.ac.kr)

Systems Software &
Architecture Lab.

Seoul National University

Spring 2022

Arrays, Pointers, and Strings I



One-dimensional Arrays (I)

■ Array

- A simple variable with an index, or subscript
- The brackets `[]` are used for array indexing
- The indexing of array elements always starts from 0
- (e.g.) `int grade0, grade1, grade2, grade3;` vs. `int grade[4];`

```
#define N 100

int a[N], i, sum = 0;

...

for (i = 0; i < N; i++)
    sum += a[i];
```

One-dimensional Arrays (2)

■ Array initialization

- Array may be of storage class automatic, external, or static, but NOT register
- Arrays can be initialized using an array initializer

```
float f[5] = {0.0, 1.0, 2.0, 3.0, 4.0};  
a[100] = {0}; /* initializes all elements of a to zero */  
a[] = {2, 3, 5, -7}; /* same as a[4] = {2, 3, 5, -7} */
```

- If a list of initializers is shorter than the number of array elements, the missing elements are initialized to **zero**
- **external** or **static** array: If not initialized explicitly, then all elements are initialized to zero by default
- **automatic** array: not necessarily initialized

One-dimensional Arrays (3)

- Array subscripting: `a[expr]`
 - `a[i]` refers to *i*-th element of the array `a` (starting from 0)
 - No automatic bound check: if `i` has a value outside the range from 0 to `N-1`, then **run-time error** occurs or it can **silently corrupt the other data** (system dependent)
- `()` in function call and `[]` in array subscripting have
 - the highest precedence
 - left to right associativity

Example: Selection Sort

```
#include <stdio.h>

int main(void)
{
    int a[] = {1, 5, 8, 0, 2, 4, 6, 5};
    int i, j, tmp, min_idx, n;

    n = sizeof(a)/sizeof(int);
    for (i = 0; i < n-1; i++)
    {
        min_idx = i;
        for (j = i + 1; j < n; j++)
            if (a[min_idx] > a[j])
                min_idx = j;
        tmp = a[min_idx]; /* swap a[min_idx], a[i] */
        a[min_idx] = a[i];
        a[i] = tmp;
    }
    printf("After sorting: ");
    for (i = 0; i < n; i++)
        printf("%3d ", a[i]);
    printf("\n");
}
```

[1, 5, 8, 0, 2, 4, 6, 5]

[1, 5, 8, 0, 2, 4, 6, 5]

[0, 5, 8, 1, 2, 4, 6, 5]

[0, 1, 8, 5, 2, 4, 6, 5]

[0, 1, 2, 5, 8, 4, 6, 5]

[0, 1, 2, 4, 8, 5, 6, 5]

[0, 1, 2, 4, 5, 8, 6, 5]

[0, 1, 2, 4, 5, 5, 6, 8]

[0, 1, 2, 4, 5, 5, 6, 8]

Example: Bubble Sort

```
#include <stdio.h>

int main(void)
{
    int a[] = {1, 5, 8, 0, 2, 4, 6, 5};
    int i, j, tmp, n;

    n = sizeof(a)/sizeof(int);
    for (i = 0; i < n - 1; i++)
        for (j = n - 1; j > i; j--)
            if (a[j-1] > a[j])
            {
                tmp = a[j-1]; /* swap a[j-1], a[j] */
                a[j-1] = a[j];
                a[j] = tmp;
            }
    printf("After sorting: ");
    for (i = 0; i < n; i++)
        printf("%3d ", a[i]);
    printf("\n");
}
```

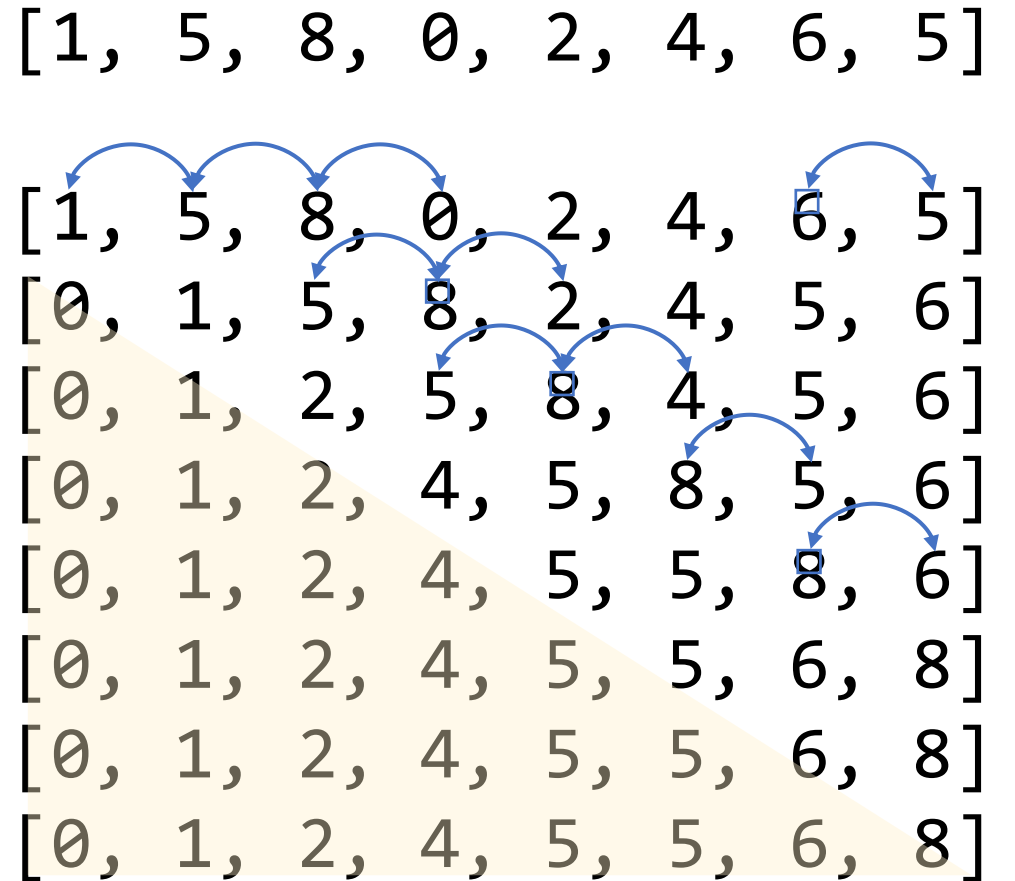

Pointers (I)

■ & operator

- Unary address operator, right-to-left associativity
- If `v` is a variable, then `&v` is the **address** (location) in memory space

■ Pointer variable

- A variable which takes addresses as values
- Can be declared in program
- When we want to declare `p` as a pointer variable, we should declare `*p` like a simple variable
(e.g.) `int *p;`

Pointers (2)

■ * operator

- Unary "indirection" or "dereferencing" operator, right-to-left associativity
- If p is a pointer, then $*p$ is the **value** of the variable of which p is the address
- The direct value of p is a memory location
- $*p$ is the indirect value of p , namely, the value of the memory space of which address is stored in p

```
int v;  
int *p = &v;
```

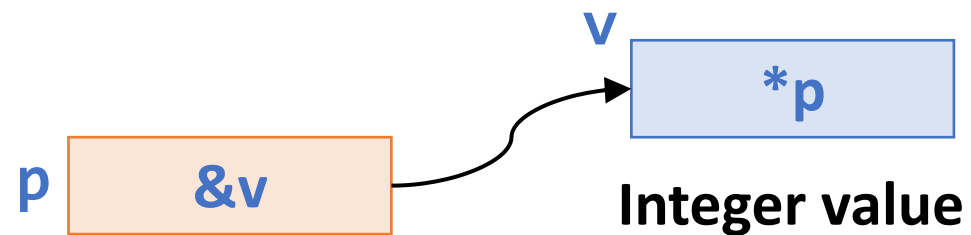

Pointers (3)

- A legal value of pointer variable

- A special address 0 (or `NULL` in `<stdio.h>`)
- Positive integers being interpreted as machine addresses

- `p = 0;`

- `p = NULL;` `/* equivalent to p = 0; */`

- `p = &i;`

- `p = (int *) 1776;` `/* an absolute address in memory */`

Pointers (4)

```
int a = 1, b = 2, *p;
```



Since a value of p has not been assigned, we do not know yet what it points to

```
p = &a; "p is assigned the address of a"
```

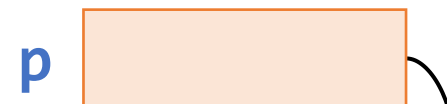

```
b = *p; "b is assigned the value of storage pointed to by p"
```

```
b = *p;  $\Leftrightarrow$  b = a;
```

Pointers (5)

```
#include <stdio.h>

int main(void)
{
    int i = 7;
    int *p = &i;

    printf("Value of i: %d\n", *p);
    printf("Location of i: %p\n", p);
    return 0;
}
```

Value of i: 7

Location of i: 0x7fffe995c7ec

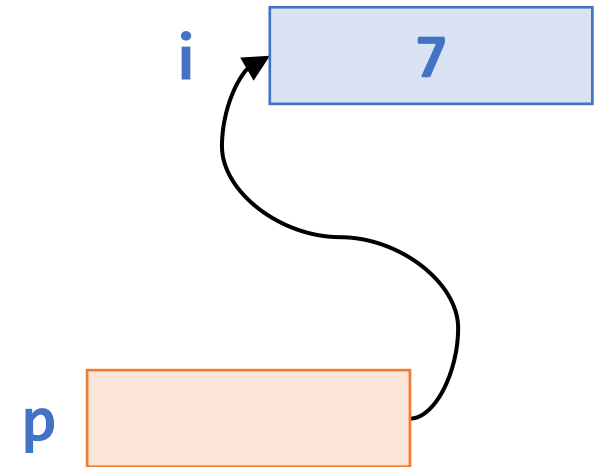

Pointers (6)

Operator	Associativity
<code>() [] ++ (postfix) -- (postfix)</code>	Left to right
<code>+ (unary) - (unary) ++ (prefix) -- (prefix) ! & (address) * (dereference)</code>	Right to left
<code>* / %</code>	Left to right
<code>+ -</code>	Left to right
<code>< <= > >=</code>	Left to right
<code>== !=</code>	Left to right
<code>&&</code>	Left to right
<code> </code>	Left to right
<code>?:</code>	Right to left
<code>= += -= *= /= %= etc.</code>	Right to left
<code>, (comma operator)</code>	Left to right

Pointers (7)

Declarations and initializations

```
int i = 3, j = 5, *p = &i, *q = &j, *r;  
double x;
```

Expression	Equivalent expression	Value
<code>p == &i</code>	<code>p == (&i)</code>	1
<code>**&p</code>	<code>*(&p)</code>	3
<code>r = &x</code>	<code>r = (&x)</code>	<i>/* illegal */</i>
<code>7 * *p / *q + 7</code>	<code>((7 * (*p)) / (*q)) + 7</code>	11
<code>*(r = &j) *= *p</code>	<code>(*(&j)) *= (*p)</code>	15

Pointers (8)

- Conversions during assignment between different pointer types are allowed
 - When one of the type is a pointer to `void`
 - When the right side is the constant `0`

Declarations and initializations	
<code>int *p; float *q; void *v;</code>	
Legal assignments	Illegal assignments
<code>p = 0;</code>	<code>p = 1;</code>
<code>p = (int *) 1;</code>	<code>v = 1;</code>
<code>p = v = q;</code>	<code>p = q;</code>
<code>p = (int *) q;</code>	

Call-by-Reference

- "Call-by-value": parameter passing in C
 - The values of variables in the calling environment are unchanged
- "Call-by-reference" mechanism
 - For changing the values of variables in the calling environment
 1. Declaring a function parameter to be a pointer
 2. Using the dereferenced pointer in the function body
 3. Passing an address as an argument when calling the function

Call-by-Value vs. Call-by-Reference

call-by-value

```
#include <stdio.h>

void swap(int p, int q)
{
    int tmp = p;
    p = q;
    q = tmp;
}

int main(void)
{
    int i = 3, j = 5;
    swap(i, j);
    printf("%d %d\n", i, j);
    return 0;
}
```

call-by-reference

```
#include <stdio.h>

void swap(int *p, int *q)
{
    int tmp = *p;
    *p = *q;
    *q = tmp;
}

int main(void)
{
    int i = 3, j = 5;
    swap(&i, &j);
    printf("%d %d\n", i, j);
    return 0;
}
```

Arrays and Pointers (I)

- An array name by itself is an address
- Arrays and pointers
 - Both can be subscripted
 - A pointer variable can take different addresses as values
 - An array name is a fixed address (constant pointer)

- $a[i] \Leftrightarrow *(a+i)$
- $*(p+i) \Leftrightarrow p[i]$
- $p = a; \Leftrightarrow p = \&a[0];$
- $p = a + 1; \Leftrightarrow p = \&a[1];$

```
int a[100], *p;
```

Arrays and Pointers (2)

```
int a[100], *p;
```

- $a + i$
 - A pointer arithmetic
 - Points to the i -th element of the array (counting from 0)
 - Has as its value the i -th offset from the base address of the array, a
- $p + i$
 - Represents the i -th offset from the value of p
 - The actual address produced by such an offset depends on the type that p points to

Arrays and Pointers (3)

```
#define N 100
int a[N], i, *p, sum = 0;
```

```
for (i = 0; i < N; i++)
    sum += a[i];
```

```
for (i = 0; i < N; i++)
    sum += *(a+i);
```

```
for (p = a; p < &a[N]; p++)
    sum += *p;
```

```
for (p = a, i = 0; i < N; i++)
    sum += p[i];
```

- Note that because **a** is a **constant pointer**, the following expressions are illegal
 - `a = p`
 - `++a`
 - `a += 2`
 - `&a`

Pointer Arithmetic and Element Size

■ Pointer arithmetic

- If the variable `p` is a pointer to a particular type,

`p + 1` `p + i` `++p` `p += i`

```
double a[2], *p, *q;
p = a;           /* points to base of array */
q = p + 1;       /* equivalent to q = &a[1]; */
printf("%ld\n", q - p); /* 1 is printed */
printf("%ld\n", (long) q - (long) p); /* 8 is printed */
```

■ `q - p`

- yields the int value representing the number of array elements between `p` and `q`

Arrays as Function Arguments

- In a function definition, a formal parameter that is declared as an array is actually a pointer
 - When an array is passed as an argument to a function, the base address of the array is passed "call-by-value"

```
double sum(double a[], int n) /* <=> double sum(double *a, int n) */ {
    int i;
    double s = 0.0;
    for (i = 0; i < n; i++)
        s += a[i];
    return s;
}
int main(void) {
    double v[100];
    ...
}
```

Various ways that sum() might be called

Invocation	What gets computed and returned
sum(v, 100)	v[0] + v[1] + ... +v[99]
sum(v, 88)	v[0] + v[1] + ... +v[87]
sum(&v[7], k-7)	v[7] + v[8] + ... +v[k-1]
sum(v+7, 2*k)	v[7] + v[8] + ... +v[2*k + 6]

Example: Bubble Sort (Revisited)

```
#include <stdio.h>

void swap(int *p, int *q)
{
    int tmp;
    tmp = *p, *p = *q, *q = tmp;
}

void bubble(int d[], int n) /* void bubble(int *d, int n) */
{
    int i, j;

    for (i = 0; i < n-1; i++)
        for (j = n-1; j > i; j--)
            if (d[j-1] > d[j]) /* if (*(d+j-1) > *(d+j)) */
                swap(&d[j-1], &d[j]); /* swap(d+j-1, d+j) */
}
```

```
int main(void)
{
    int a[] = {1, 5, 8, 0, 2, 4, 6, 5};
    int i, n = sizeof(a)/sizeof(int);

    bubble(a, n);
    printf("After sorting: ");
    for (i = 0; i < n; i++)
        printf("%3d", a[i]);
    printf("\n");
}
```

Dynamic Memory Allocation (I)

- `#include <stdlib.h>`
- `void *malloc(size_t size);` `/* memory allocation */`
- `void *calloc(size_t n, size_t size);` `/* contiguous allocation */`

```
#include <stdio.h>
#include <stdlib.h>

int main(void)
{
    int *a;           /* to be used as an array */
    int n;           /* the size of the array */
    ...
    a = calloc(n, sizeof(int)); /* get space for a */
    if (a != NULL)
        ...
}
```

Dynamic Memory Allocation (2)

- `ptr = calloc(n, sizeof(int));`
 - The allocated memory is initialized with all bits set to zero
- `ptr = malloc(n * sizeof(int));`
 - The allocated memory space is not initialized
- Space having been dynamically allocated **MUST** be returned to the system upon function exit
- `void free(void *ptr);`
 - *ptr* must be the base address of space previously allocated

Example: Merge Sort (I)

- How to merge two pre-sorted arrays in a sorted order?

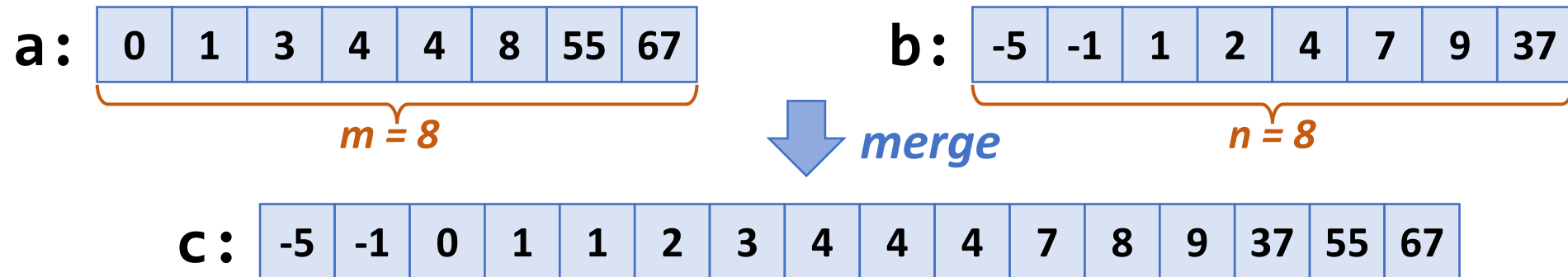

merge.c

```
#include "mergesort.h"

void merge(int a[], int b[], int c[], int m, int n) {
    int i = 0, j = 0, k = 0;
    while (i < m && j < n)
        c[k++] = (a[i] < b[j])? a[i++] : b[j++];
    while (i < m) c[k++] = a[i++];
    while (j < n) c[k++] = b[j++];
}
```

Example: Merge Sort (2)

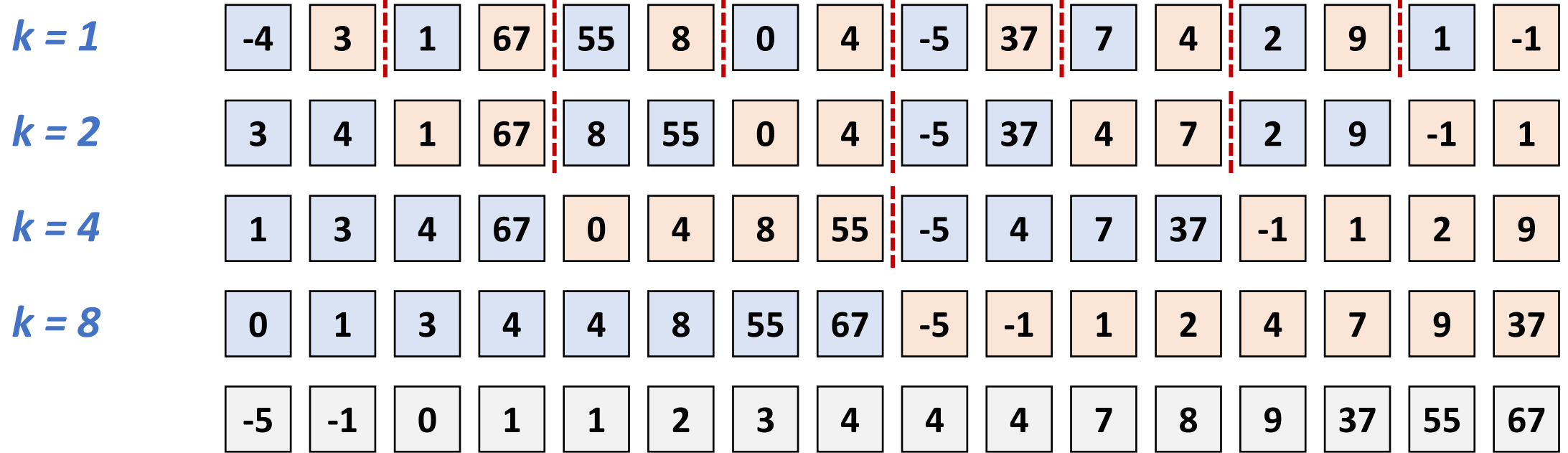

```

for (i = 0; i < n; i += 2*k)
    merge(key+i, key+i+k, w+i, k, k);
for (i = 0; i < n; i++) key[i] = w[i];
    
```

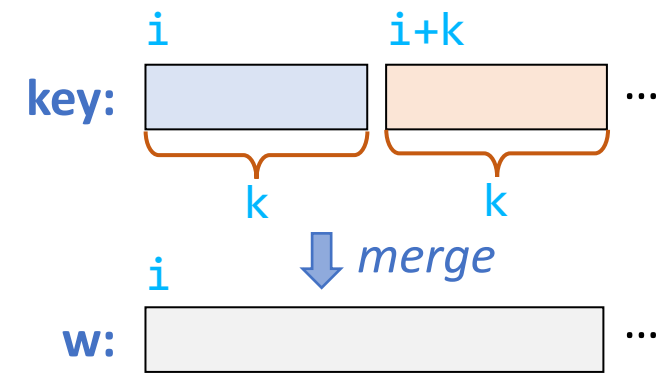

Example: Merge Sort (3)

mergesort.c

```
#include "mergesort.h"

void mergesort(int key[], int n)
{
    int i, k, m, *w;

    for (m = 1; m < n; m *= 2);
    if (n < m) exit(1);
    w = calloc(n, sizeof(int));    /* allocate temporary storage */
    assert(w != NULL);
    for (k = 1; k < n; k *= 2)
    {
        for (i = 0; i < n; i += 2*k)
            merge(key+i, key+i+k, w+i, k, k);
        for (i = 0; i < n; i++) key[i] = w[i];
    }
    free(w);    /* free temporary storage */
}
```

Example: Merge Sort (4)

main.c

```
#include "mergesort.h"

int main(void)
{
    int sz;
    int key[] = {4, 3, 1, 67, 55, 8, 0, 4, -5, 37, 7, 4, 2, 9, 1, -1};

    sz = sizeof(key)/sizeof(int);
    printf("Before mergesort:\n");
    printkey(key, sz);
    mergesort(key, sz);
    printf("After mergesort:\n");
    printkey(key, sz);

    return 0;
}
```

Example: Merge Sort (5)

printkey.c

```
#include "mergesort.h"

void printkey(int key[], int n)
{
    int i;

    for (i = 0; i < n; i++)
        printf("%3d ", key[i]);
    printf("\n");
}
```

```
$ gcc -o mergesort mergesort.c merge.c
printkey.c main.c
$ ./mergesort
```

mergesort.h

```
#include <assert.h>
#include <stdio.h>
#include <stdlib.h>

void merge(int a[], int b[], int c[], int m, int n);
void mergesort(int key[], int n);
void printkey(int key[], int n);
```